

Article number: 54301415

Description: LDK Rod end PHS 15L
Threaded left

Measures

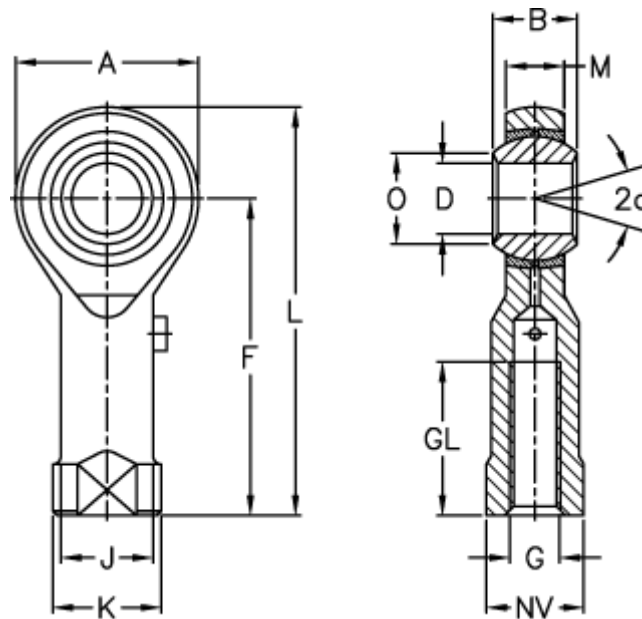

A	= 36	J	= 21.0
a (degrees)	= 16	K	= 26
B	= 20	L	= 79
D	= 15	M	= 14.00
Dynamic load C (kN)	= 14.5	NV	= 22
F	= 61	O	= 18.10
g	= M14	Static load C0 (kN)	= 33.0
GL	= 30	Weight (g)	= 186.0